





What is K2

K2 is an information processing technology that enhances sound quality of digital sound sources, co-developed in 1987 by JVC (currently JVCKENWOOD) and Victor Studio of Victor Music Industries (currently Victor Entertainment). It features a number of proprietary technologies, including technology to analyze waveform data that tends to vary from moment to moment within the time domain. Most notable is the fact that the technology was developed through rounds of testing and auditioning by Victor Studio engineers, who are experts in music and sound creation. Based on the vast amount of original master sound sources owned by Victor Studio, "K2 Technology" is a group of technologies that aim at faithful reproduction of the original source as far as possible by passing through the sound quality check carried out by the studio engineers who are thoroughly versed in audio and musical quality.

Restore the original sound feeling based on the concept of "Undo"

Fundamental Principles of K2

K2 does not tamper with sound quality to make it sound flamboyant, or exaggerate it. The aim of the development concept is to produce the same quality as the original music source, and the principle is to faithfully restore the sound that existed in its original form. The two keyphrases that were emphasized during development were "the original sound without any changes" and "restoring sound to its original state." This principle remains unchanged for K2 even today. Responding to changes in the environment and the way to enjoy music, "K2" will continue to evolve.



Development background of “K2 technology”

Origin of K2

The name K2 was taken from the initials of the two engineers who developed the system (Kuwaoka from Victor Company of Japan, and Kanai from Victor Studio).

Development History of K2

The development of K2 was started in response to calls from recording engineers in Victor Studio. They objected to the common idea that there was absolutely no change in sound quality no matter how many times the original data was copied when the music media is transferred from analog records across to digital CDs. Because digitalizing sound is encoded in combinations of zeros and ones. Although no changes occur in theory, the studio engineers claimed that there was a clear difference between the sound quality of the original master and the copied sub-master. So the engineers at JVCKENWOOD set about to clarify the reason for this. Subsequently, it was discovered that although the digital data was exactly the same, electrical distortion (jitter, rippling), etc. occurred when the data was being recorded and saved, which had an adverse effect when converting music played back in digital into analog, thereby proving that changes did occur in sound quality. An attempt by the two engineers to improve the changes in sound quality that occurred at this time led to the original version of K2, which was named the “K2 Interface.” Efforts in creating high-quality sound of digital sources with K2, which started from a signal transmission system at a music content production studio, will continue to evolve and expand from being featured in playback equipment to the remastering of songs, cutting records, and more.



Main technologies of K2



Example of K2 Technology Implementation

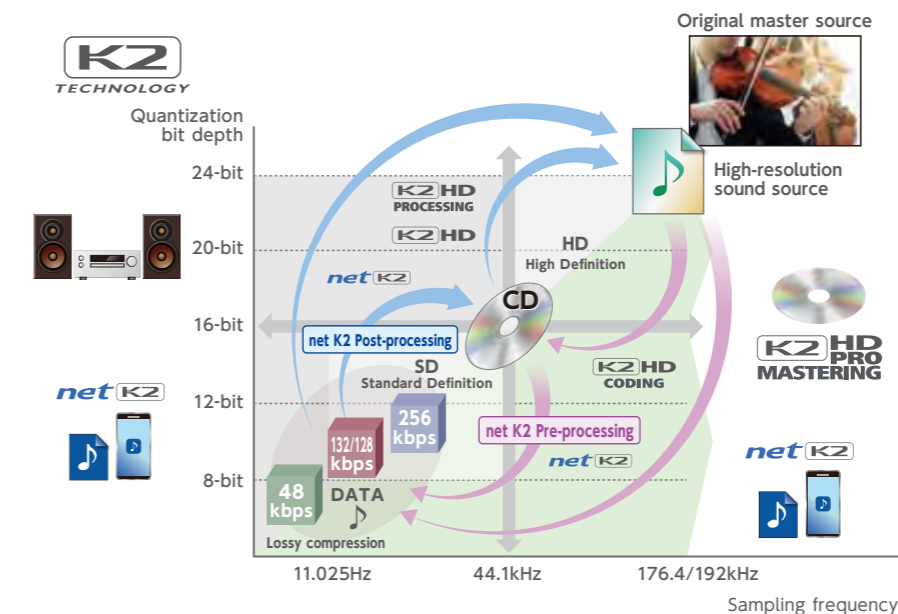

Timeline

- 1987 K2 INTERFACE developed
- 1993 20bit K2 super coding developed / 20bit K2 AD convertor developed
- 1994 20bit K2 processing developed / 20bit K2 DA convertor developed / K2 laser cutting developed
- 1995 20bit K2 Pro / super coding method developed
- 1996 xrcd developed
- 1997 EXTENDED K2 processing developed
- 1998 DIGITAL K2 developed / xrcd2 developed
- 1999 EXTENDED K2 processing Ver.2.0 developed
- 2000 CC Convertor developed
- 2001 DVD K2 developed
- 2002 ENC K2 developed / CCCD K2 / xrcd24 developed
- 2003 K2 process engine developed
- 2004 K2 high-definition coding developed
- 2005 net K2 high-quality sound music distribution technology developed
- 2006 net K2 mobile phone music application developed
- 2007 Licensing for net K2 and K2HD Mastering started
- 2008 K2HD MASTERING+CRYSTAL developed
- 2010 K2HD MASTERING+SERIES developed
- 2012 net K2 iPhone application developed
- 2012 K2HD PROCESSOR developed
- 2016 K2HD PRO MASTERING developed
- 2017 Optimized for Bluetooth® wireless technology



“net K2 Technology” Applied For Compressed Audio (MP3, WMA, AAC, ATRAC3, etc) and Music Distribution. At the beginning of development, “net K2” was distinguished as the information processing in the compression system, but the current “K2HD” technology includes this processing function, so it is collectively called “K2HD processing”.

K2 Features

1. Technological innovation comes from uniting the technology of hardware and sensibility of software

K2 was co-developed by audio equipment engineers who make hardware, and studio engineers who create the software for sound production. A round of back and forth during the development stage took place where a studio engineer would evaluate a prototype designed by the hardware engineer on a trial basis, and the hardware engineer reflects the sound direction and improvements pointed out by the software engineer in a specific design, and the studio engineer would once again evaluate the sound quality. By way of analogy, this is like cooking, where the best, freshest ingredients would be wasted if the end result wasn't tasty, but it's also true that taste isn't all that matters because the quality of ingredients is also important. So a perfect dish can only be created by having an experienced chef who is capable of carefully selecting the right ingredients, and improve the taste by having the dish evaluated in an objective manner. Sound quality goes through an identical process. If you don't actually hear a difference in sound quality, it is worthless no matter how ideal the theory, specs, circuitry or parts may be. It's also important to remember what's being evaluated is not just sound, but music. Professionals from all fields come together to continue developing K2 as it keeps evolving. At JVCKENWOOD Group, we have the ideal one-of-a-kind development environment, where software and hardware experts who are familiar with sound quality and how to transmit music collaborate.

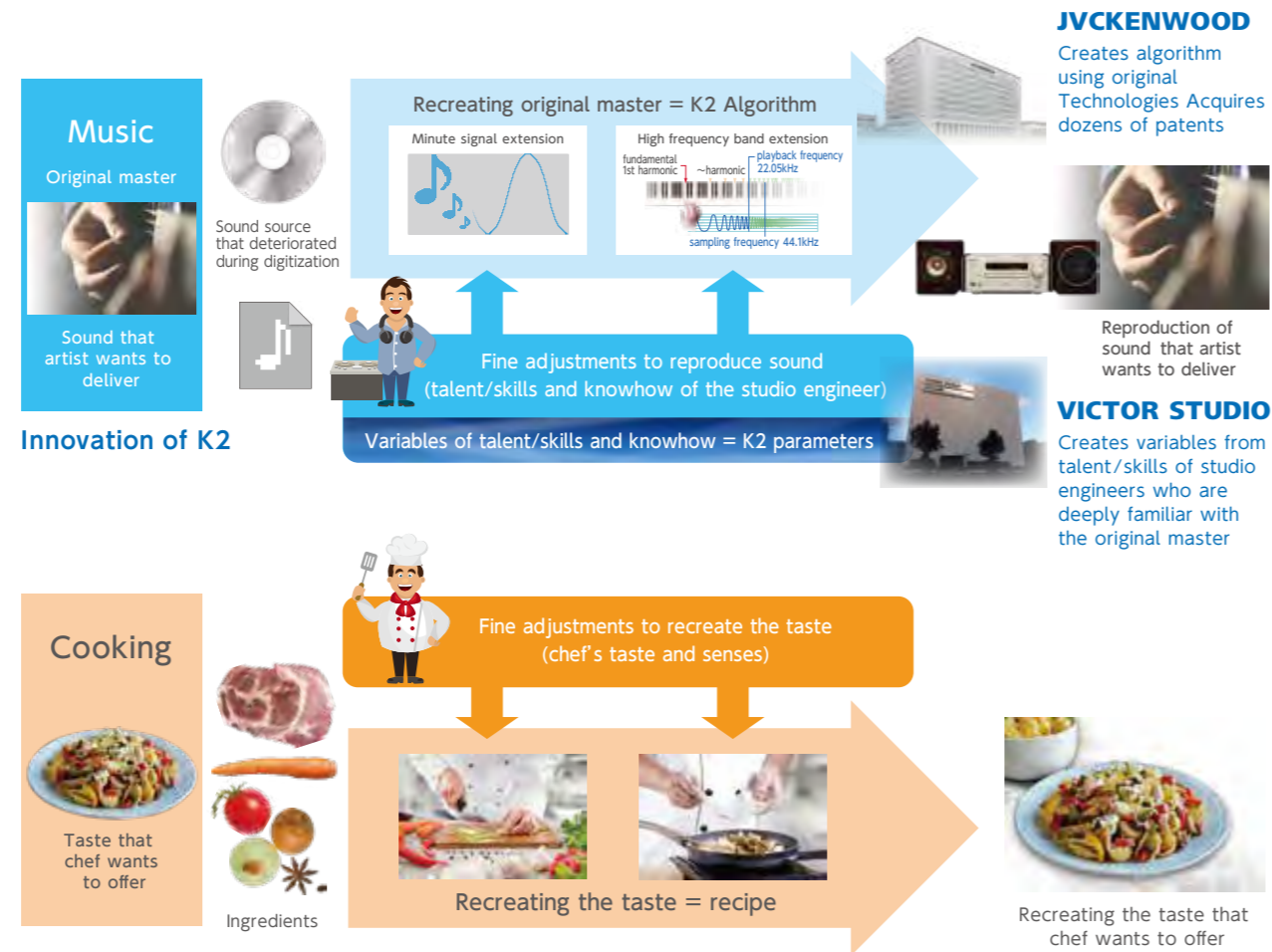

2. Signal processing at time domain

Instead of using the frequency domain, which is applied in similar technologies that restore data lost during digitization using frequency data, K2HD Processing uses the time domain to perform signal processing. This method restores lost data by analyzing each peak in the time-varying waveform; it is a unique method that no other audio manufacturer has used in the past.

The sounds of many instruments are based on harmonics, much of which are lost during digitization. K2 Technology creates the artist's musical expressions and subtle timbre of different musical instruments by analyzing waveform signals based on the time axis.

It is a technology that is only possible with K2, as it processes based on the time axis not the frequency domain.

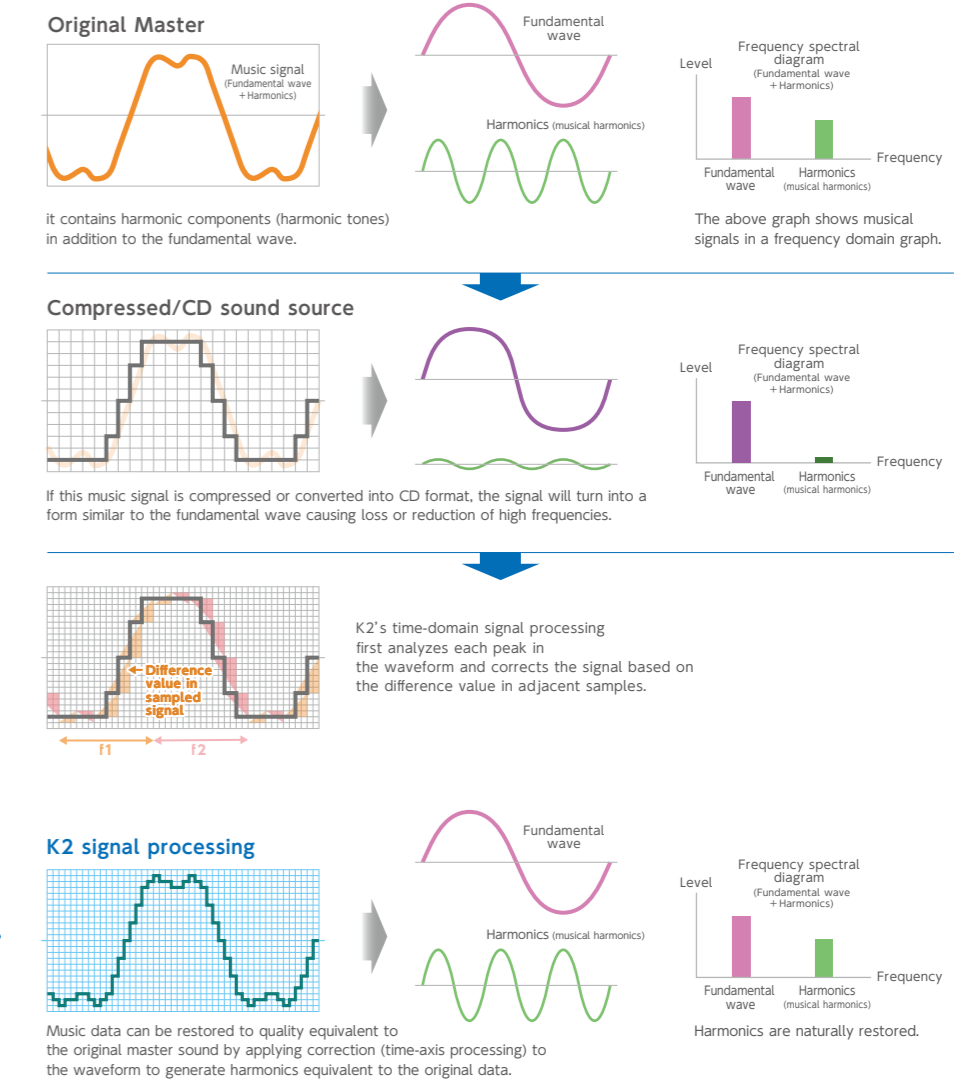
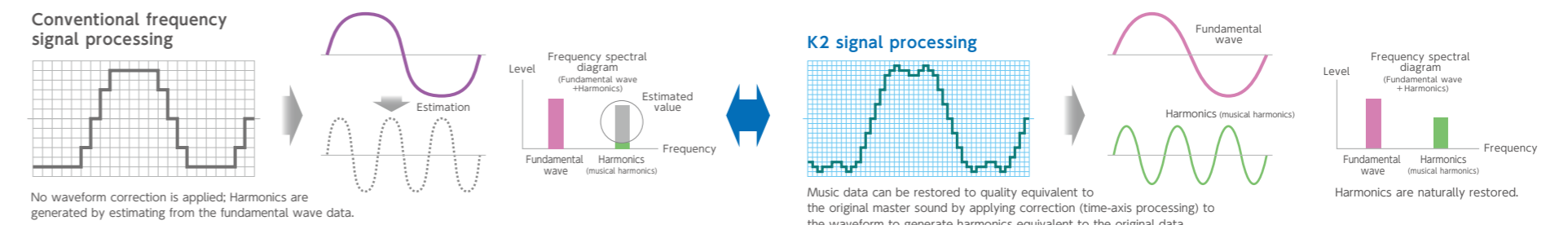

K2 in sound equipment

K2 Technology is divided into two main groups of “High-definition transmission technology” and “High-quality sound technology”.

■ High-definition transmission technology



▶ Used to make equipment and products more precise

■ High-quality sound technology



▶ Up-converting low-grade format sound sources to high-grade format



▶ Down-converting high-grade format sound sources to low-grade format

K2 Interface



High-definition transmission technology K2 Interface

K2 Interface is a high-definition sound technology in the transmission system of digital data based on the concept of K2, which is “reproducing or restoring to the original state without any changes”. It is applied to minimize deterioration of sound quality caused by copying a music source or the use type of digital equipment. Various factors (such as jitters and ripples from recording or reading data) that may exert change in sound quality are eliminated or digital data itself is regenerated, even when the digital data of the source and destination are the same.

This technology was developed as the first generation K2 Interface.

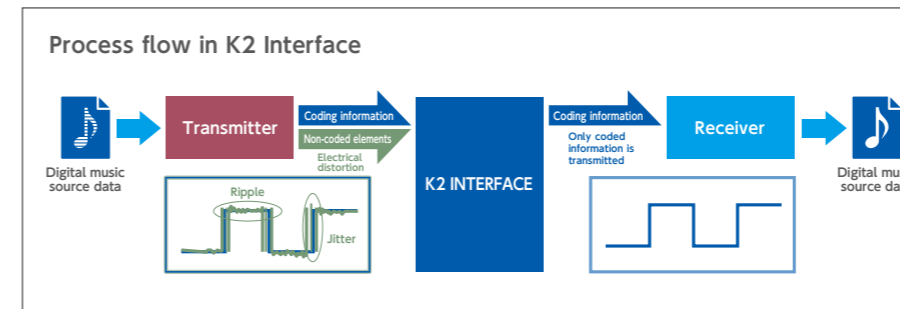

Professional spec K2HD Processor for mastering equipped with K2 Interface (Victor Studio)

Correctly restores the music data as it knows the original source

K2 HD PROCESSING **K2 HD** High-quality sound technology K2HD Processing

K2HD Processing is a high-quality sound technology made possible by processing digital data that is derived from one of the fundamental principles of K2, "to restore or return to the original state". Degraded sound sources, which are created by compressing the sound source or converting to a limited format or specs, can be restored to a quality equivalent to the original master. Up to 192 kHz high-frequency range extension (for CD sources: Expands playback frequency from 22.05 kHz to 96 kHz) and bit extension or minute signal extension (for CD sources: bit depth is expanded from 16-bit to 24-bit) are applied to create timbre equivalent to the original and the power needed for sound expression.

■ High-frequency range extension

Harmonics is a key element in timbre. The sound of both musical instruments and voices are composed of multiple frequencies, and the lowest-frequency sound is called the "root". Frequencies that are integral multiples of the root are mixed to create timbre. (Musical instruments produce different timbre even when playing the same frequency because of differences in harmonics.) With CDs, analog sound is converted into digital sound using a sampling frequency^{*1} of 44.1 kHz; thus its playback frequency^{*2} will be up to 22.05 kHz and overtones (harmonics) in higher frequencies are eliminated.

The original algorithm (waveform correction process) featured in the high-frequency range extension in K2HD Processing that utilizes the expertise of Victor Studio, restores cut-off harmonics in the high-frequency range from the remaining sound to reproduce music expression equivalent to the original master.

^{*1} : Sampling frequency : The number of samples per second in sound that is acquired when an analog signal is converted into a digital signal (AD conversion).
^{*2} : Playback frequency : Sound frequency that can actually be played back. The value of the playback frequency is half the sampling frequency. In order to playback the humanly audible frequency range of 20kHz, CDs sample analog sound at 44.1 kHz.

Restoring harmonics of high frequency range

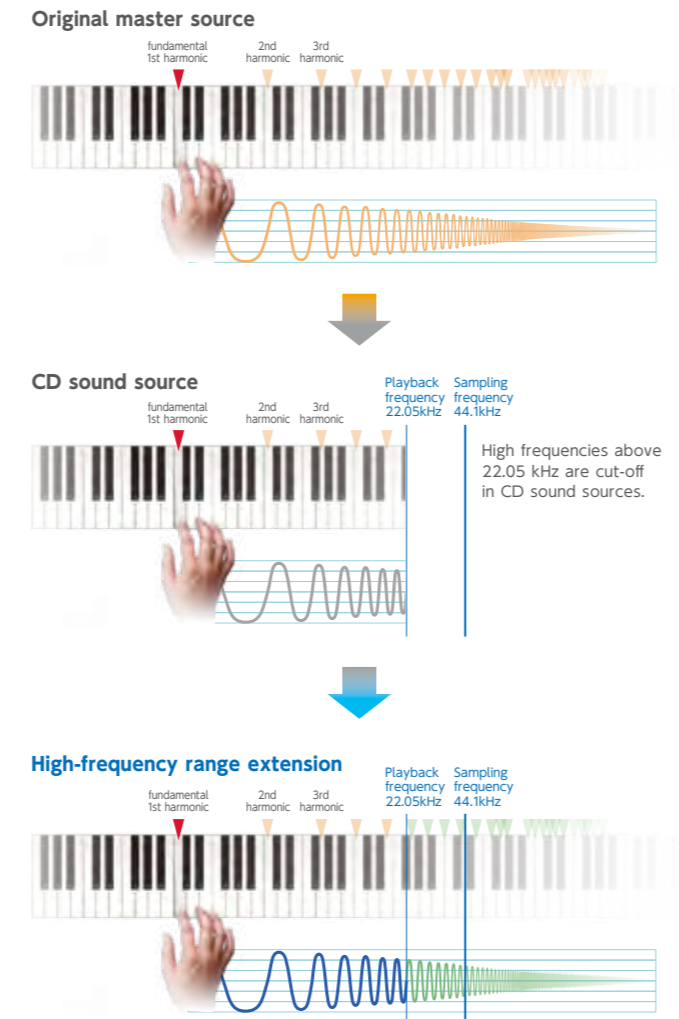

Minute signal extension

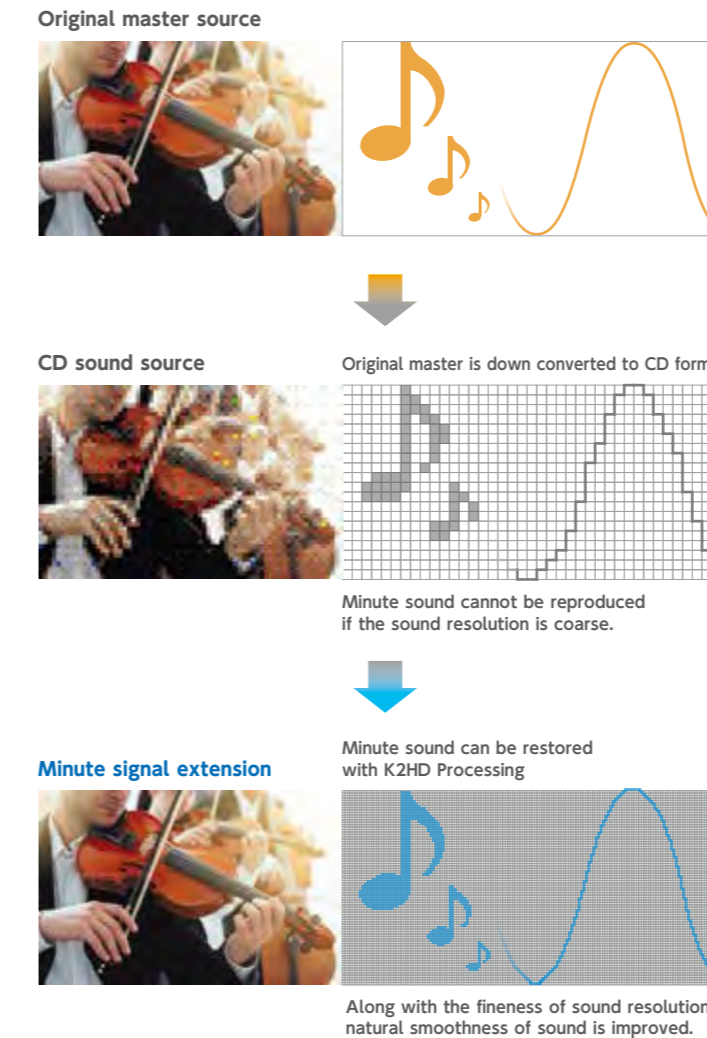

■ Minute signal extension (Bit extension)

When converting an analog signal to a digital signal, the number of steps to reproduce the loudness from silence to maximum volume affects the expressiveness of music such as its smoothness and subtlety. CDs express from silence to a maximum volume in 65,536-step resolution because it is 16-bit (2 to the power of 16). However, 16,777,216-step resolution can be achieved with 24-bit extension, allowing reproduction of minute signals not heard on CDs for music with a large volume differences like classical music, to reproduce realistic sound full of ambience such as breath and fine details of strings. With K2HD Processing, Victor Studio's expertise is added as a variable to this bit extension to achieve more natural, smooth sound.

K2HD Processing is not a simple up sampling / bit extension (conversion) for high frequency bands or minute signals of degraded / deteriorated digital sound sources; rather, it is capable of restoring the sound quality equivalent to a master sound source by applying Victor Studio engineers' sound creation expertise into the extension process. When K2HD Processing is implemented, it is possible to achieve sound faithful to deliver "the sound the artist intended" even for compressed digital sound sources.

K2 in music content production



K2HD CODING



High-quality sound technology (coding technology) K2HD Coding

In digital sound production, when storing master music sources having their vast amount of information into a limited confined format, K2HD Coding is used to maintain musical expressions contained in the original music source. It is capable of storing upper-format digital music sources of up to 192 kHz/24-bit as lower-format 44.1kHz/16-bit music sources.

Thanks to the equivalent exchange of music energy, the high frequency range of 20 kHz and higher in playback frequency (which is normally eliminated in CD format), is modified to 20 kHz or less allowing it to be used within CD format frequencies. This enables conventional CDs to be played back including musical expressions with resolution of up to 192 kHz/24-bit specifications.

Also, if CD format is the only sound source available, reproduction of CD content with expressive power close to the original master can be achieved by expanding the frequency with K2HD Processing and re-coding the data back to CD format.

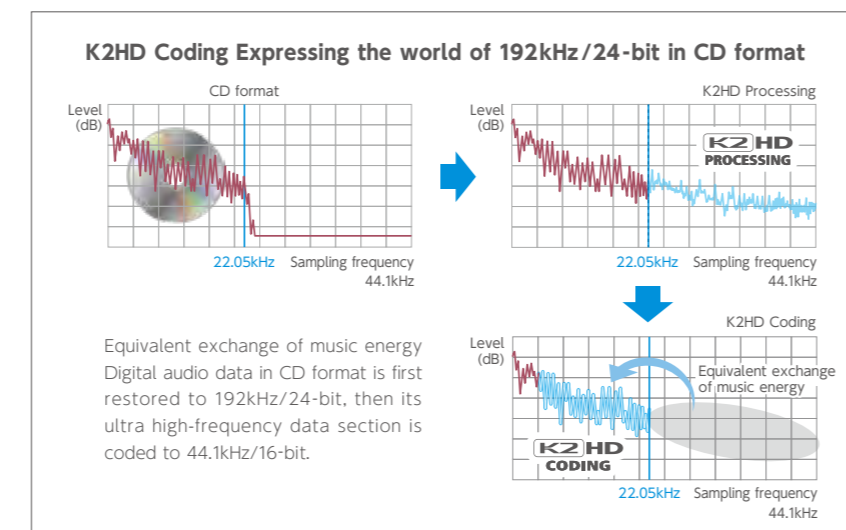

K2HD PRO MASTERING

VICTOR STUDIO

Infusing the value of
the original master into
each medium

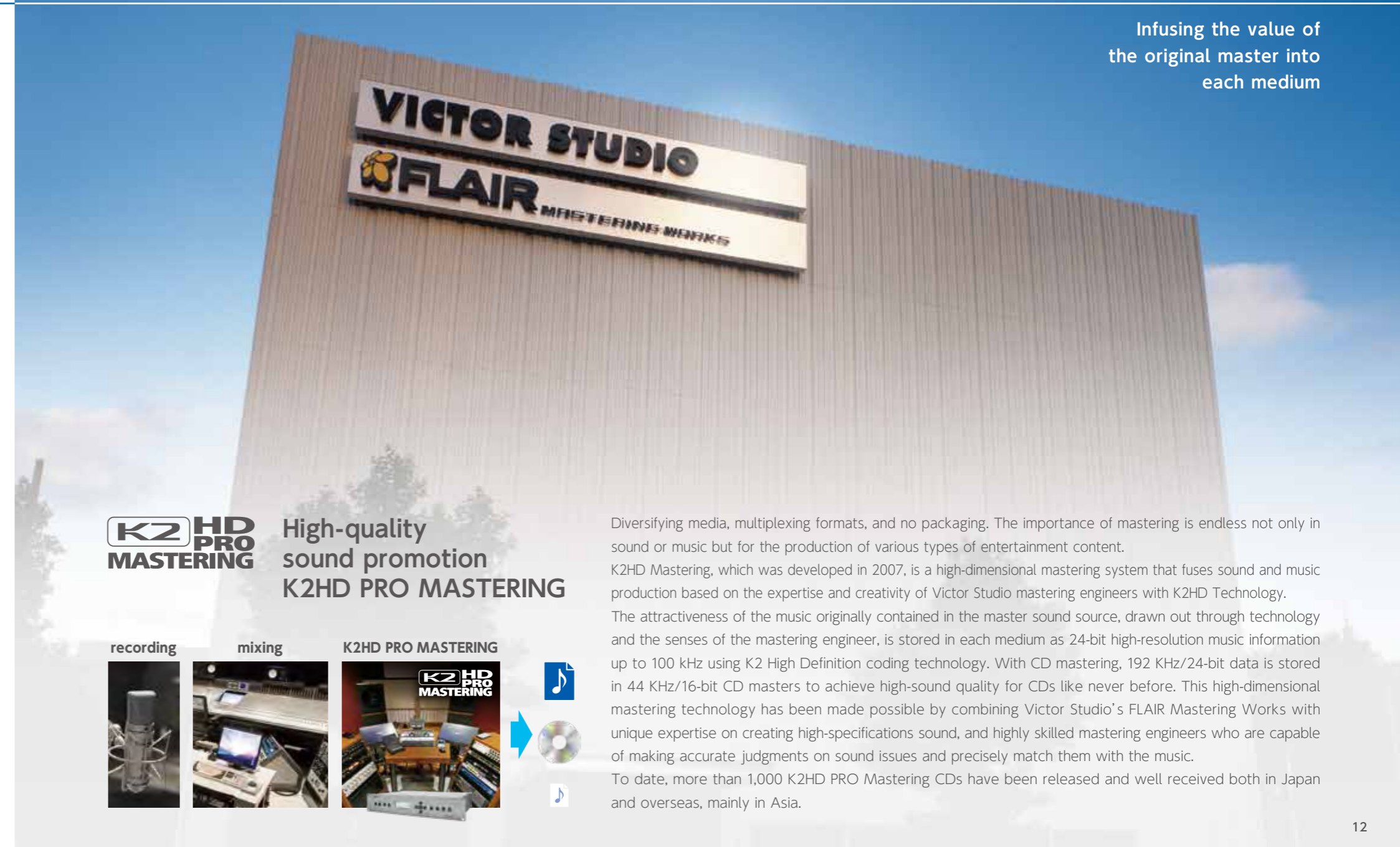

High-quality sound promotion K2HD PRO MASTERING

recording

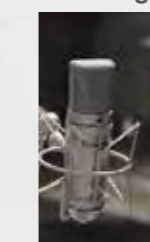

mixing



K2HD PRO MASTERING

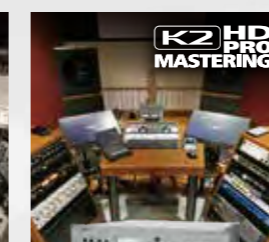

Diversifying media, multiplexing formats, and no packaging. The importance of mastering is endless not only in sound or music but for the production of various types of entertainment content.

K2HD Mastering, which was developed in 2007, is a high-dimensional mastering system that fuses sound and music production based on the expertise and creativity of Victor Studio mastering engineers with K2HD Technology.

The attractiveness of the music originally contained in the master sound source, drawn out through technology and the senses of the mastering engineer, is stored in each medium as 24-bit high-resolution music information up to 100 kHz using K2 High Definition coding technology. With CD mastering, 192 kHz/24-bit data is stored in 44 kHz/16-bit CD masters to achieve high-sound quality for CDs like never before. This high-dimensional mastering technology has been made possible by combining Victor Studio's FLAIR Mastering Works with unique expertise on creating high-specifications sound, and highly skilled mastering engineers who are capable of making accurate judgments on sound issues and precisely match them with the music.

To date, more than 1,000 K2HD PRO Mastering CDs have been released and well received both in Japan and overseas, mainly in Asia.



Achieving high-quality sound equivalent to the original high-resolution sound, even used wirelessly.

Sound source restoration with K2

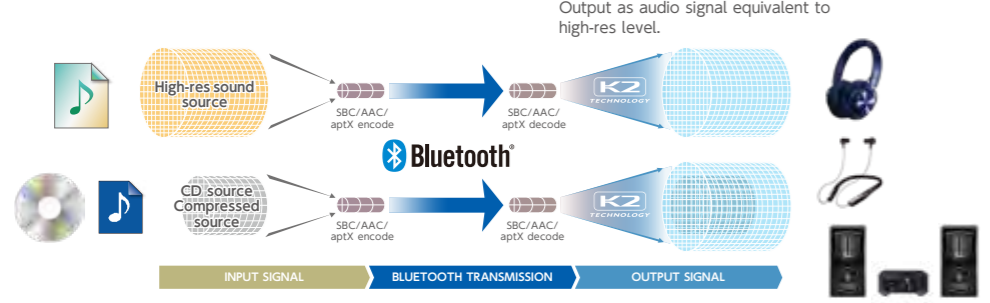

Waveform correction parameters for each codec are optimized; when paired with Bluetooth®, waveform correction is performed by using the parameters that support the selected codec. The output audio signal will be equivalent to high-res level (192 kHz/ 24-bit format).

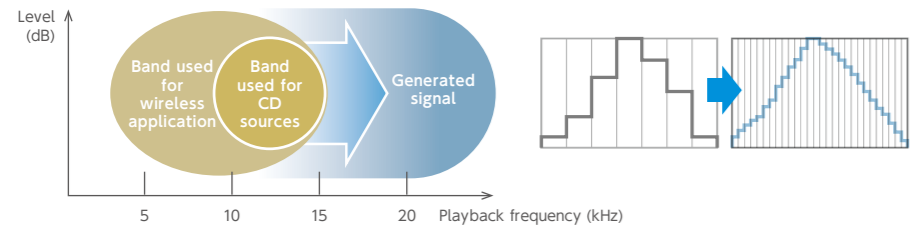

K2 Technology has been optimized to match Bluetooth® wireless technology

K2 Technology can help solve the issue of sound deterioration due to the increasing number of wireless audio equipment. Audio data is sent wirelessly by compressing data using one of the codecs (e.g. SBC, AAC, Qualcomm®, aptX™ audio, etc.) with Bluetooth® wireless technology. Compared to wired technology, there is a drawback in terms of sound quality with Bluetooth® due to degradation caused by compression. In order to regenerate the lost music data during wireless transmission, K2 Technology can process the signal using optimum parameters that match each codec to achieve sound quality close to that of wired transmission. K2 Technology can make sound sources of widely available Bluetooth®-compatible equipment, such as smartphones, equivalent to high-res level.

Broad and smooth sound can be played back with waveform correction processing optimum for the Bluetooth® wireless technology

In order to regenerate lost audio data caused by the compression process in Bluetooth® wireless technology, high-precision waveform correction is performed by extending the processing range until lower frequency band than the one used conventional CD sound sources. The signal is then output as a high-res equivalent (192 kHz/24-bit format) music signal. As a result, broad and smooth sound close to the original master can be achieved.

Major Patents of the K2 : In Japan

Patent number	Name of the invention
4123486	Digital sound processing method and digital sound processor, as well as computer program
5023794	Digital sound processor and digital sound processing program
5023812	Digital sound processor and digital sound processing program
4985570	Digital acoustic sound signal processing method and processor
6256293	Digital sound processor, digital sound processing method, and digital sound processing program
6511988	Digital sound processor, digital sound processing method, and digital sound processing program
6844504	Digital sound processor, digital sound processing method, and digital sound processing program

Registered Trademarks : In Japan

Registered trademark number	Registered logo	Technology name
5528899	K2 TECHNOLOGY	K2 TECHNOLOGY
5580641	K2 HD CODING	K2HD CODING
5580642	K2 HD PROCESSING	K2HD PROCESSING
5910096	K2 HD PRO MASTERING	K2HD PRO MASTERING
6648798	K2 HD	K2HD

JVCKENWOOD products equipped with "K2 technology"+





JVCKENWOOD Corporation

3-12, Moriyacho, Kanagawa-ku, Yokohama-shi, Kanagawa, 221-0022, Japan

www.jvckenwood.com

Issue : FEB 01, 2024
No. JK-T0004

Supervision : K2 Promotion, Underlying Technology Research Group, Future Creation Research Laboratory, JVCKENWOOD Corporation,
VICTOR STUDIO, JVCKENWOOD Victor Entertainment Corporation

Production : JVCKENWOOD Design Corporation